

Package Type

Oversea-safe transportation box with foam inlet

Package Content

- HS WeatherSens model with 10 m cable
- HS Calibration and test-certificate (FTC)
- Installation Guide HS WeatherSens

Available Versions

- 2 Parameter (Wind): WS200
- 5 Parameter (W/T/RH/P): WS500
- 5 P + Radiation or Precipitation: WS600/601/650

Factory Settings

- SDI-12 V 1.3
- RS 485 protocols disabled; Setting by key user commands with Baudrate 9600-8N1

Tube 1

- 1 Sensor
- 2 M6 screw and spring
- 3 Cable and plug
- 4 Fixing rod (OD50mm)

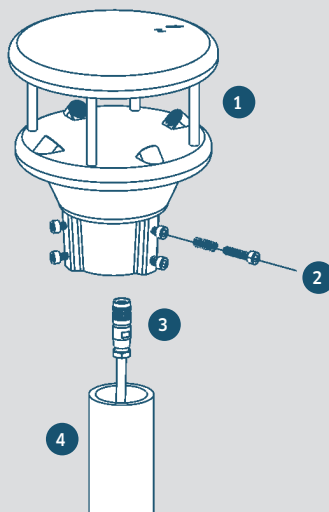

Mounting Method & Alignment

Alignment Method

- The measurement of wind direction is closely related to the mounting position of the weather sensor. During mounting, align the indicator arrow „N“ at the top of the sensor with 0° phase.
- Before fixing the instrument, the sensor should be aligned in such a way that the indicator arrow “N” points to the North - South direction of the earth’s geographic meridians.
- The North can be referred either to true north, which uses the earth’s geographic meridians, or to the magnetic north, which is read with a magnetic compass. The magnetic declination is the difference in degrees between the true north and magnetic north. When aligning to the magnetic North, the declination (variation) must be taken into account.

Procedure

1. If the sensor is already installed, loosen both nuts evenly until you can turn the sensor easily
2. Using the compass, identify the North and fix a point of reference on the horizon
3. Position the sensor in such a way that the South and North sensors are in alignment with the fixed point of reference in the North

Alignment Method

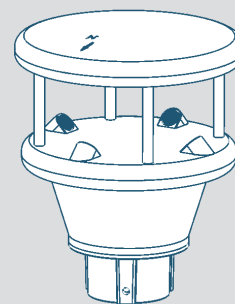

WS200
Ø126 mm / 0.5 kg

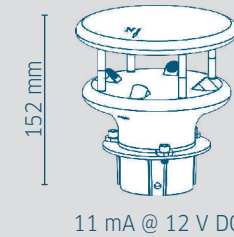

WS500
Ø126 mm / 0.6 kg

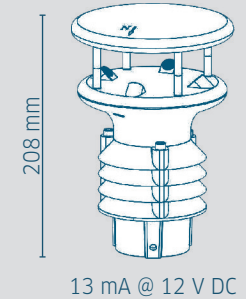

WS600
Ø126 mm / 0.7 kg

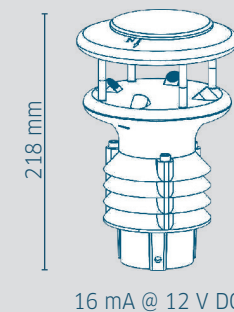

WS601
Ø126 mm / 0.8 kg

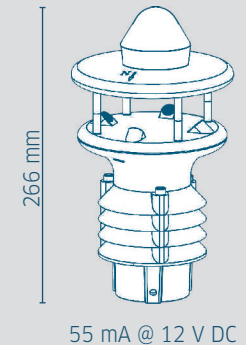

WS650
Ø126 mm / 0.7 kg

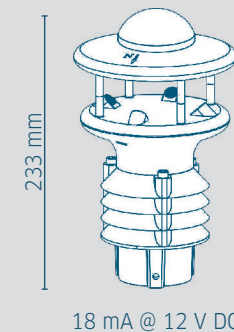

*Illustration does not represent all versions.

Serial Interface

Serial interfaces can be selected either SDI-12 or RS485 by key user commands through RS485/USB converter connected to PC by standard terminal SW

Function	Sets	Commands	Detail
Switch to SDI-12 protocol under any protocol	1	\$AACFG 1<CR><LF>	AA:address,Default:00,1:Back to ASCII mode
	2	\$AAQ 4<CR><LF>	Select SDI-12 protocol
Switch to MODBUS-RTU Floating protocol under any protocol	1	\$AACFG 1<CR><LF>	AA:address,Default:00,1:Back to ASCII mode
	2	\$AAQ 2<CR><LF>	Select MODBUS-RTU Floating protocol

Sensor Connection and Cable Assignments

- All non-heated HS WeatherSens MP-Series devices are equipped with M12-8pol connector (male)
- Connection towards data-logger and power supply to be applied with corresponding accessories sensor cables type M12 SAC-8pol

Caution: Un-proper or false connection can damage the instrument.

Illustration and drawings below do demonstrate the sensor cables only. Shield to be connected to PE inside control cabinet or data logger by booth end grounding.

Sensor Cable M12 SAC-8pol

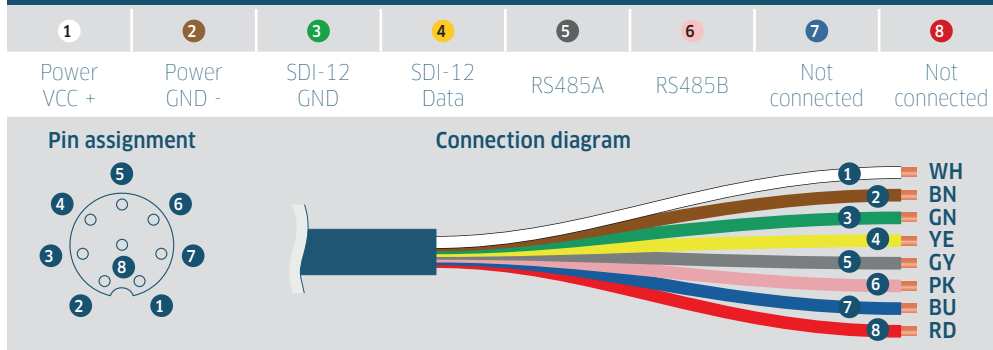

Measurements

	WS200	WS500	WS600	WS601	WS650
wind speed	✓	✓	✓	✓	✓
wind direction	✓	✓	✓	✓	✓
temperature		✓	✓	✓	✓
relative humidity		✓	✓	✓	✓
air pressure		✓	✓	✓	✓
rainfall			✓ (piezoelectric)	✓ (photoelectric)	
solar radiation					✓

Technical Specifications

IP Class	IP66
Interfaces	SDI-12 / RS 485 (selectable)
Protocols	SDI-12 V 1.3 or RS485 (MODBUS-RTU, ASCII; NMEA 0183, UMB)
Operating Voltage	10 to 30 VDC
Operating Temperature and Humidity	-40 to +70 °C; 5 % to 100 % RH (without snow accumulation and/or ice accretion)
Connector and Cable	Connector M12-8pol; 10 m cable

Parameters

	Wind Speed	Wind Direction	Temperature	Relative Humidity	Air Pressure	Rainfall	Rainfall	Solar Radiation
Principle	Ultrasonic	Ultrasonic	Diode voltage	Capacitive	Piezo-resistor	Piezo-electric	Piezo-electric	Photo-electric
Range	0 to 45 m/s	0 to 359.9°	-40 to +80 °C	0 to 100 % RH	500 to 1100 hPa	0 to 200 mm/h	0 to 400 mm/h	300 to 2100 nm; 0 to 2000 W/m ²
Accuracy	±0.3 m/s or 3 %	±3°	±0.3 °C*	±3 % RH	±0.3 hPa	±5 %	±5 %	±5 %

*+0.2 °C @ 0 to +40 °C

Connection table

	SDI-12	RS485
Power VCC +	WH	WH
Power GND -	BN*	BN
SDI-12 GND	GN*	-
SDI-12 DATA	YE	-
RS485A	-	GY
RS485B	-	PK

*Optional for 4 wire SDI-12 connection. Connection of Power GND - is mandatory and recommended for 3 wire SDI-12 connection.